



An Intelligent Technique to Mitigate the Transient Effect on Circuit Breaker due to Occurrence of Various Types of Faults

Shripati Vyas, R. R. Joshi and Vinod Kumar Yadav

EasyChair preprints are intended for rapid dissemination of research results and are integrated with the rest of EasyChair.

March 2, 2021

An Intelligent Technique to Mitigate the Transient Effect on Circuit Breaker due to Occurrence of Various Types of Faults

Shripati Vyas¹, R.R. Joshi², Vinod Kumar³

¹²³Department of (Electrical Engineering)

¹²³(College of Technology and Engineering / MPUAT / Research Scholler)

(Udaipur, Rajasthan, India 313001)

Abstract- This research work aims to simulate the effect on circuit breaker due to various types of faults occurred in distribution network. The various faults like single line to ground fault (L-G), double line to ground fault (2L-G), triple line to ground fault (3L-G) and line to line fault (L-L) are simulated and their effect on circuit breaker is also studied. Such type of fault causes failure to open and close, failure to operate as required etc., the various reasons behind these failures are increased contact resistance, damaged mechanical parts, decreased insulation. In this paper, an artificial neural network (ANN)-based technique is applied to indicate the severe damage and to monitor the failure modes in advance.

Keywords—Condition Monitoring System (CMS), Maintenance strategies, Artificial Neural Networks (ANN), Circuit breaker, Faults

I. Introduction

Usually, a power system operates in balanced condition but in any abnormality, the system can get unbalanced. If there is any failure in its insulation or two or more phases working at different voltages comes into contact then there is possibility of any fault. There are several reasons of fault occurrence like high winds, snow and surges etc. There may be some another causes like dropping of trees on line, accidents with supporting structures and lower insulation may cause faults etc. There is a greater possibility of short circuits due to defected insulation caused by aging or overloading of conductors. Hence, during power system analysis the fault analysis is of crucial importance. There is need of protective relays for protection from greater short circuit currents while disconnecting the faulty part.

At the time of selection of circuit breakers and relays, we should approximate the degree of currents which will flow under faulty conditions that is the part of fault study. Selection of phase relays is done by 3L-G fault data and the ground relays

are selected on the basis of L-G faults. There are very less chance of 3L-G faults in system, most of the occurred faults are of 2L-G and L-G. In our investigation we have included the asymmetrical faults because their effect is most severe in system, while the symmetrical faults are very uncommon in nature.

The power system fault can be divided into mainly two parts that are symmetrical and asymmetrical. In the occasion of symmetrical faults, the fault current is equal for all the three phases and network is in balanced condition while in unsymmetrical condition the fault current magnitudes are dissimilar for every phase. The various types of faults are;

1. L-G fault (Single-line-ground fault)
2. Double-line-ground fault
3. Three-line-ground fault

These faults are also called as short circuit fault which are common on transmission lines. Such faults take place due to different factors like insulation failure of equipment caused by lightning and switching surges are coming in contact and also when foreign object came in contact with bare power lines [6]. The foreign objects may be falling of trees on line or birds shorting outlines. In this paper we are using a MATLAB Simulink. MATLAB stands for matrix laboratory. MATLAB is a high-performance language for technical computing it has many advantages compare to convectional computer language for solving a technical problem, this software is available since from 1984 and is considered as standard tool. MATLAB can be used for graphical and programmatically analysis, MATLAB as many tool boxes and we are using Simulink for graphical modelling.

II. Modelling and Simulation

In this model we are using three phase sources of 13.8 kv, 50 Hz is connected to the series RLC load with an impedance of load in ohms, and it is connected through transmission lines. Three transmission lines are used of 50 km long, while one of the transmission lines is parallel to the two series transmission lines: here two-way supply given to the RLC series load through transmission lines since our main aim to create fault in one of the transmission lines during that time the supply is not interrupt to the load. To isolate that unhealthy part, we are using circuit breaker for switching operation that is, open and close of the circuit breaker, the circuit breaker operation is opposite to that ideal switch that is, if ideal switch is open circuit

breaker remains in closed condition, vice versa. The operation is similar to double-line -ground fault, three-line- ground fault but while double-line-ground fault two line of transmission line is short circuited and three line of transmission line is short circuited for three-line-ground fault. The obtained results can be calculated theoretically by using formula.

a. Single-line-ground fault

There are three phases that is phase – a, phase – b and phase – c, during single – line – ground fault it is assumed that phase – a shorted to ground directly. Where ($V_a= 0, I_b= 0, I_c= 0$) and the fault current is $I_f = 3(E_a / Z_1 + Z_2 + Z_3)$

b. Double-line-ground fault

The fault takes place in phases b and c, this phases shorted ground directly. Then the condition is ($V_b = 0, V_c= 0$ and $I_a= 0$) and the fault current is $I_f= - 3 I_{a1} (Z_2/ Z_1+Z_2)$

c. Three – line – ground fault

Here three phases are shorted ground directly. The condition is $I_a + I_b + I_c= 0$ and $V_a= V_b= V_c$, the fault current is $I_f = E_a/ Z$

Figure 1 presents a model which is designed in MATLAB tool box, the network is having voltage generation source of 13.8 kV, 50Hz, having pre-fault from 1 to 5 cycle at CB1. The system has three circuit breakers that are installed in transmission line. The fault is created near CB1 and then circuit breaker voltages and currents are investigated.

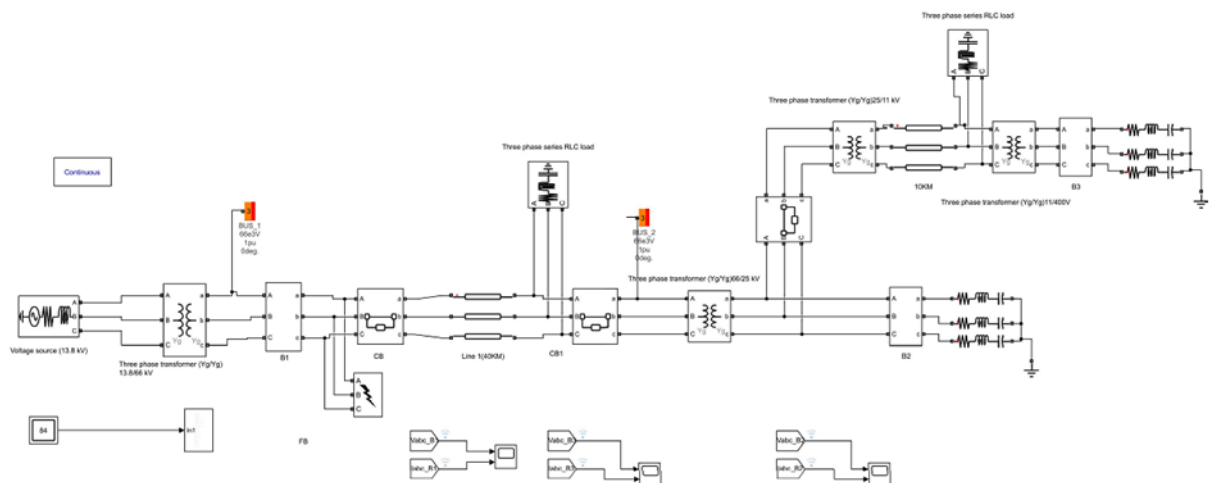

Fig.1. Proposed model for fault analysis

III. ANN based fault detection

Neural network architecture is employed to detect the fault at sending end, with the intention that the fault can be early detected and the faulty part can be removed. The designing of fault detector is done by following stages:

a. Foundation of training data set

The foundation of training data has the required details to adjust input patterns with realer output patterns. The training speed and efficiency of neural network is affected by training data set. There is mixture of several fault situations in training data set of an ANN. Preparation of training data sets is done by simulating various faults in network. For obtaining several training samples the fault phase and locations are changed. The Table.1 presents the categorization and location task.

Table -1: Training of conductor fault

Type of fault	A-G, AB-G, ABC-G
Fault location in Km	5,15,20,30,35,40,45
Inception angle of fault	0-360 (degree)

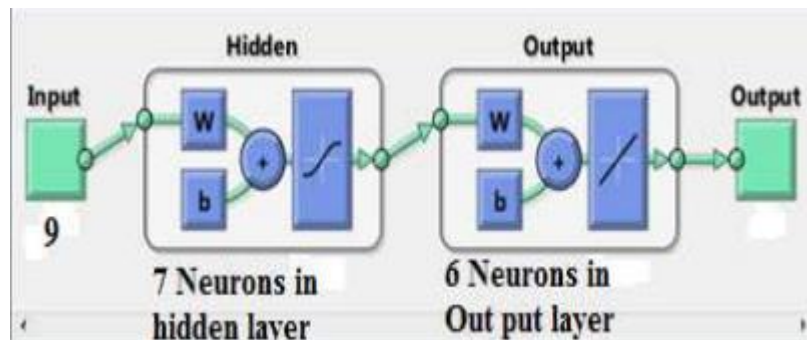

Fig-2: complete arrangement of the ANN to detect the fault

IV. Results and Discussion

The fault study of transient effect on circuit breaker has three cases which are described in this section, in these sections L-G, 2L-G and 3L-G faults are applied on transmission line.

Case I- In this case the voltage and current waveform of faulted circuit breaker and fault breaker are shown the location of fault is near to sending end. The fault type is single line to ground fault.

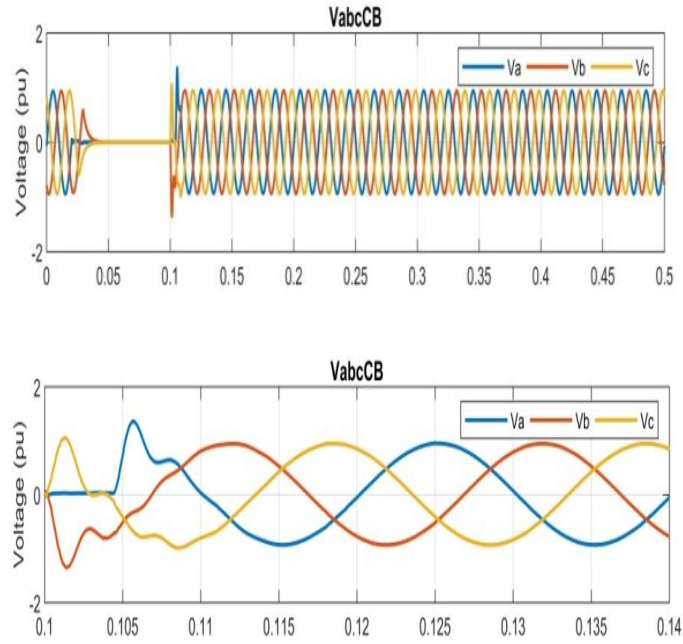

Fig. (a) Voltage waveform

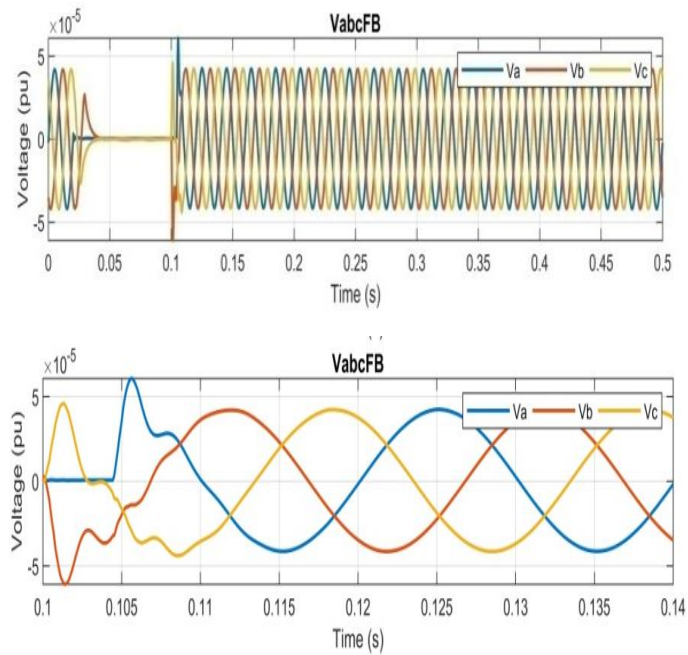

Fig. (b) Current waveform

Fig. 3 (a) & (b) shows the voltage and current waveform of faulted CB and FB respectively near to sending end under single line to ground fault.

Case II- In this case the voltage and current waveform of faulted circuit breaker and fault breaker are shown the location of fault is near to sending end. The fault type is double line to ground fault.

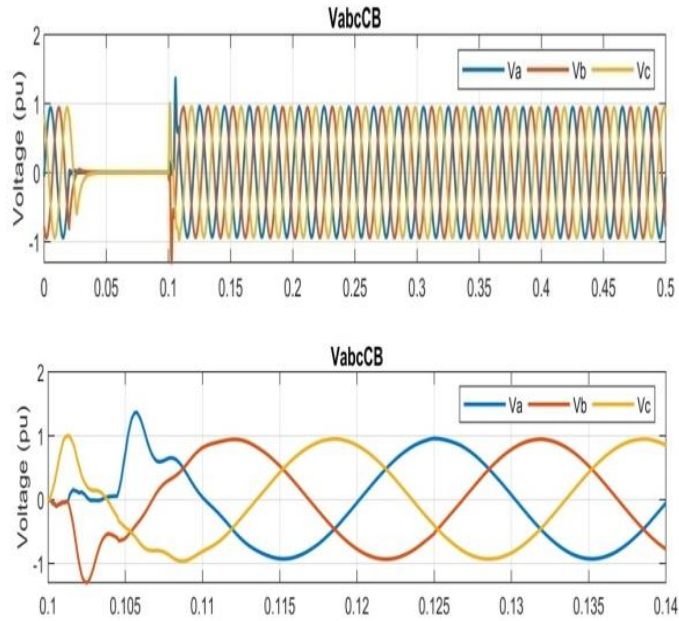

Fig. (a) Voltage waveform

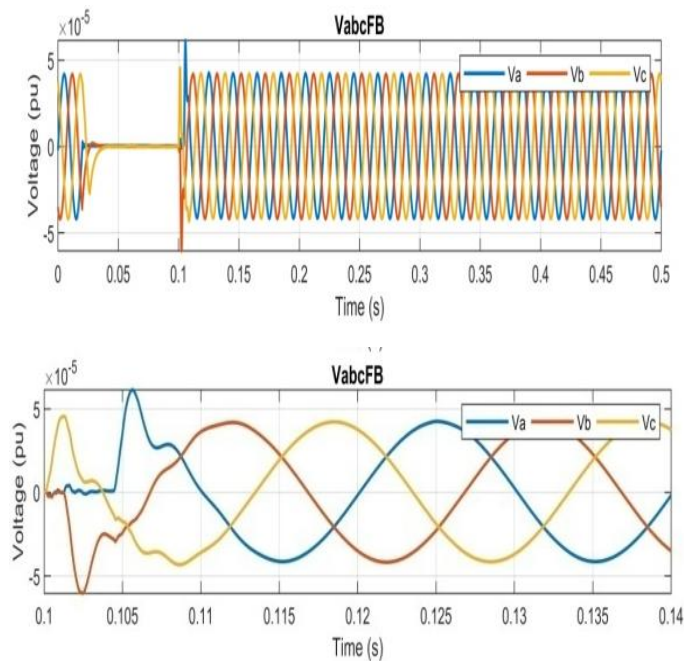

Fig.(b) Current waveform

Fig. 4 (a) & (b) shows the voltage and current waveform of faulted CB and FB respectively near to sending end under double line to ground fault.

Case III- In this case the voltage and current waveform of faulted circuit breaker and fault breaker are shown the location of fault is near to sending end. The fault type is triple line to ground fault.

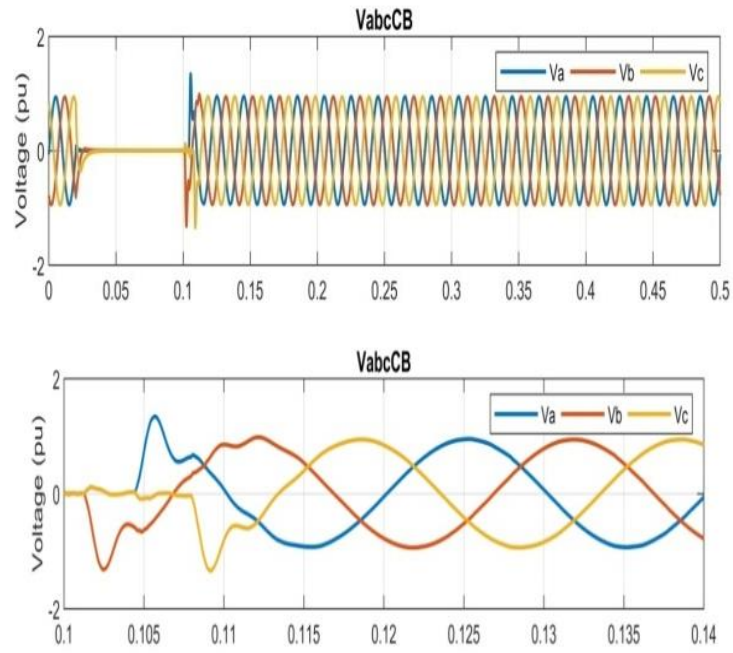

Fig. (a) Voltage waveform

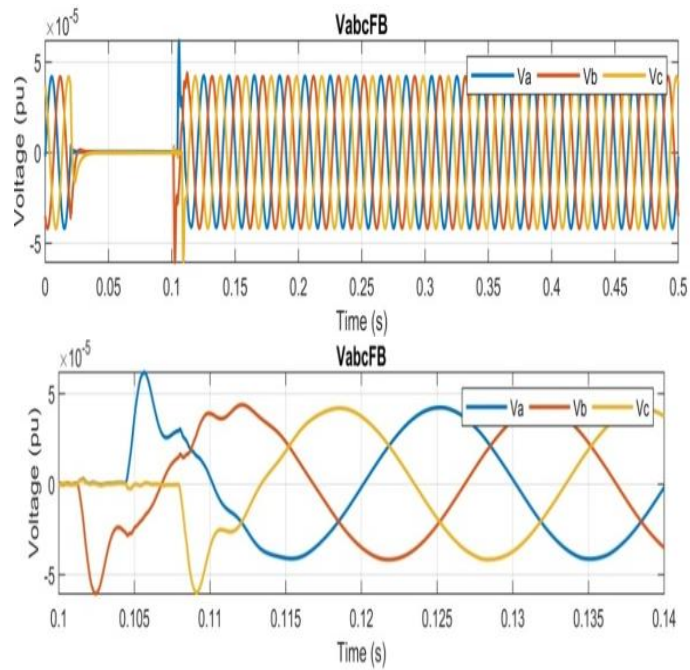

Fig.(b) Current waveform

Fig. 5 (a) & (b) shows the voltage and current waveform of faulted CB and FB respectively near to sending end under triple line to ground fault.

The testing of ANN based fault detector was done by data sets from sending end with 860 fault patterns. The system was investigated and authenticated by testing several faults at several locations. (L_f 0-45KM) and inception angles ($\Phi_i=0-360^\circ$). The operational time ANN based fault detector can be computed as:

Operation time = pattern number required for detection x sampling time.

Table: 2 Required output of ANN based fault detector

Type of fault	Phase	A	B	C	G
Single phase to ground	A-G	1	0	0	1
	B-G	0	1	0	1
	C-G	0	0	1	1
Double phase to ground	AB-G	1	1	0	1
	BC-G	0	1	1	1
	CA-G	1	0	1	1
Triple phase to ground	ABC-G	1	1	1	1

V. Conclusions

The simulation study of various type of faults at several locations is done using MATLAB Sim-power system and Simulink toolbox is done and the effect of faults on circuit breaker is also presented. Artificial neural network-based fault detector is designed and investigated. The test results shows that by employing ANN based fault detecting approach we can get early detection of fault at the circuit breaker and it may be saved from damage by monitoring the fault in advance and its location.

References

- [1] Shakuntla B, Yadav M, Kumar N (2019), MATLAB simulation-based study of various types of faults occurring in the transmission lines, international journal of engineering research & technology (IJERT) 08.
- [2] Pooja P, Preethi KR, Chetan HR, Nandish BM (2016) Three phase transmission line fault analysis using MATLAB Simulink, International Journal of science & engineering development research, 1: 376 – 378.
- [3] Wanying Qiu, (2011) Simulation Study of Single Line-to-Ground Faults on Rural Teed Distribution Lines, and Computing Technologies in Agriculture IV, Springer Berlin Heidelberg, pp 521—524.
- [4] Tharani, Vijaya & Nandhini, M & Sundar, R & Nithiyanthan, K. (2016). MATLAB based Simulations model for Three phase Power System Network.
- [5] Sushmita Srivastava, Km. Reshu, Smriti Singh, (2014) Mathematical Calculation and MATLAB Programming of Symmetrical and Asymmetrical Faults in Power System, pp 184-187.

[6] Boora, Dr. (2019). MATLAB Simulation Based Study of Various Types of Faults Occurring in the Transmission Lines. International Journal of Engineering Research.

[7] Paul Gill, Electrical power equipment maintenance & Testing, CRC press.