



## Fluid Viscosity Measuring Instrument With Internet Of Things (IoT) Based Rotary Method

---

Herry Sufyan Hadi, Putri Yeni Aisyah and Syamsul Arifin

EasyChair preprints are intended for rapid dissemination of research results and are integrated with the rest of EasyChair.

July 31, 2021

# Fluid Viscosity Measuring Instrument With Internet Of Things (IoT) Based Rotary Method

**H S Hadi, P Y Aisyah, S Arifin**

Instrumentation Engineering Department, Vocational Faculty, Sepuluh Nopember Institute of Technology (ITS) Surabaya, East Java

sh\_herry@yahoo.co.id, putriyeniaisyah@gmail.com, arifinsymsl25@gmail.com

**Abstract.** The viscometer is a system measuring the viscosity value of a liquid substance. The function of this viscosity measuring instrument is used to analyze the viscosity level of a particular product so that it is easy to know the quality of fluid viscosity. In this study, two methods were conducted, namely simulation and experimentation. Simulations were conducted using Simulink Matlab while experiments were conducted by designing fluid viscosity measuring instruments by rotary method or commonly known as a rotational viscometer. This tool uses two sensors namely, rpm sensor to measure rpm of dc motor and current and voltage sensor to measure current from dc motor, and also use controller equipped with Internet of Things (IoT) so that the measurement results will be displayed through LCD and can be monitored through the website. From the simulation results obtained drum motor spinning at low speed to the 10th second of the motor rotation about 6 rad / s and as time increases, the motor rotation will increase until the 60th second of the motor rotation begins to be constant this is due to the large shear voltage produced by a fluid at the beginning of the motor is turned on very large and decreases over time. While the test results of the tool that has been designed, obtained the measurement results on SAE 40 Oil obtained accuracy results of 0.99, on the measurement of SAE Oil 20W-50 obtained an accuracy value of 0.99 and in the measurement of SAE 10W-30 Oil obtained an accuracy value of 0.99. This tool can also be used in practical activities in one of the Measurement Engineering Courses where I studied, namely the Department of Instrumentation Engineering. This tool can also be used in practicum activities in one of the Measurement Engineering Courses in which I studied, namely its Instrumentation Engineering Department.

**Keywords: Viscometer, Rotary Method, Simulink Matlab, Monitoring, IoT**

## 1. Introduction

One of the measuring instruments needed in the industrial world is the viscometer. The viscometer is a system of viscosity value gauge (viscosity) of a liquid substance [1]. The function of this viscosity measuring instrument is used to analyze the viscosity level of a particular product so that it is easy to know the quality of fluid viscosity. Examples of industries that require viscometers are industries that produce products in the form of liquids such as lubricants, oil processing, paints, chemicals, etc.

Viscosity is a measure of viscosity of liquid substances. Viscosity values are indispensable in determining the physical properties of liquids. Because viscosity value affects a product to be produced. For example, in the food production process, if the viscosity value in food is high it will refer to the flour and glucose substances present in the food [2]. The second example is in vehicle lubricants, in cylinder temperature vehicles, gears and driving engines can be affected by oil viscosity

. In addition, friction inside the engine is also affected by the viscosity of the oil [2]. The third example is in the field of health, viscosity is also needed in the field of health to measure the viscosity of blood affected by plasma viscosity and hematocrit with viskositas can be detected various diseases for example in patients who have acute cardiovascular disease such as stroke and heart attack, plasma viscosity will be higher. In addition, anemia, postmenopausal epidemic [2]. The fourth example is in the manufacturing industry, viscosity plays a role in the measurement of the viscosity of lubricants to be used in the machine. If the lubricant has too high viscosity, then the lubricant can clog the machine thus hindering the manufacturing process [2]. Liquids with high viscosity values are more difficult to flow compared to liquids that have low viscosity [3]. Conventionally, viscosity measurement has insufficient precision for that it is necessary to use a measuring instrument that is easy to use and has better precision [3]. There are several methods to measure viscosity values such as falling ball viscometer, rotational viscometer and capillary tube viscometer. Viscometer type rotation of the sumbu cylinder is based on 2 types namely Searle system and Couette system. On Searle systems the inner cylinder rotates and the outer cylinder is stationary. The opposite of the Searle system, on the Couette system the outside of the cylinder is rotated while the inside of the cylinder is still [3]. The viscometer of a falling ball is a viscosity measuring instrument that measures the time a ball passes through a liquid at a certain distance based on the principles of Stokes Law and Newton's Law [4]. While the capillary tube viscometer, the measuring instrument works using the principle of cohesion force, which cohesion is an attractive tensile force between similar molecules and in viscosity measurements has similar molecules. [5]

In this study, researchers will design fluid viscosity measuring instruments with *rotary* method or commonly known as rotational viscometer. This study used rotation-type viscometers because this type of viscometer can accurately measure non-Newtonian fluid types compared to other types because it utilizes dc motor rpm to measure fluid viscosity values. This tool uses two sensors namely, rpm sensor to measure rpm of dc motor and current and voltage sensor to measure current from dc motor, and also use *controller* equipped with Internet of *Things* (IoT) so that the measurement results will be displayed through LCD and can be monitored through the website. This system will make it easier for the user to measure a fluid. This tool can also be used in practicum activities in one of the Measurement Engineering Courses in which I studied, namely its Instrumentation Engineering Department.

## 2. Method

### 2.1 Procedure

In this final project, the outline of the final project flow can be seen in Fig. 1.

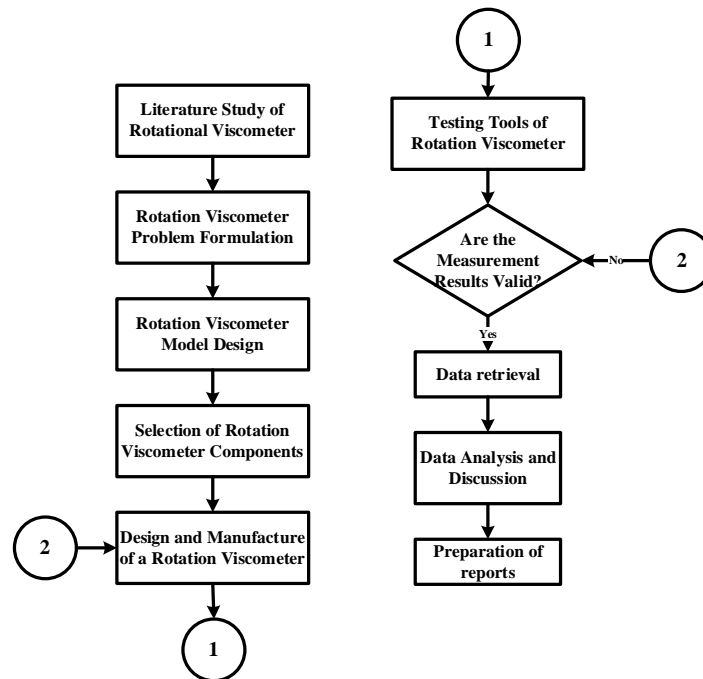

**Figure 1.** Flowchart of Final Project Viscosity Measurement Tool

In the procedure of this final project first, starting from a literature study looking for references from journals and articles regarding the viscometer fluid measuring instrument using the rotary method based on the Internet of Things (IoT) or known as a rotational viscometer. Second, the problem formulation of the viscosity measuring instrument technology that is used and raised in this final project is carried out. Third, making a model of the rotational viscometer which contains the design of the fluid viscometer. Fourth, the selection of components that will be used in making the rotational viscometer is carried out. Fifth, namely the design and manufacture of a fluid viscosity measuring instrument with a rotary method based on the Internet of Things (IoT). Sixth, a tool testing is carried out in which if the measurement results of the tool that have been made are invalid then it will do the design and remaking of the final project tool, if it is in accordance with what is expected then the data is collected then the data will be analyzed and discussed on the data. The final step of this final project is the preparation of a report on the results.

## 2.2 Design of Rotation Viscometer System Model

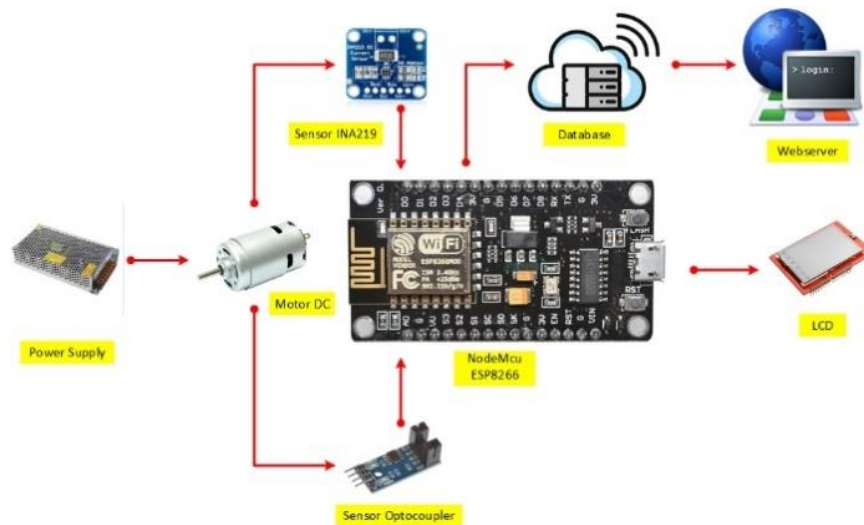

**Figure 2.** Design of Rotation Viscometer System Model

The system model in Figure 3.2 starts from the power supply that provides voltage to the DC motor and electrical circuit. When the DC motor works, the stirrer will move around stirring the liquid to be measured. Then the optocoupler sensor will sense the rpm of the DC motor and the reading value from the sensor will be sent to the controller. Likewise with the INA219 sensor, this sensor will sense the current from the DC motor which then the readings from the sensor will be sent to the controller. Then the two sensor signals are processed by the controller. Then the results of the measurements can be seen through the LCD. In addition to the data displayed on the LCD, the data can also be viewed through the website, which controller will send data to the cloud.

### 2.3 Hardware and Software Design

Hardware design is divided into 2 groups, namely mechanical design and electronic device design. In the mechanical design there is a plant of a rotational viscometer. As for the electronic design, there are several components including a 12 Volt 3 Ampere DC power supply, step down circuit, 12 Volt DC Motor, FC 03 optocoupler sensor as a DC Motor speed sensor, INA219 sensor as a DC Motor current sensor, and NodeMCU LoLin V3 ESP8266 as a DC motor speed sensor controllers. The LoLin V3 ESP8266 NodeMCU is in charge of receiving data from the speed sensor and current sensor for further processing and then the controller will send the data to the LCD for display and also to the webservice to be able to monitor the measurement results. In the software design system for the rotational method of fluid viscosity measuring instruments, several devices must be able to perform data retrieval, controller design, and data transmission. To be able to run it, this software design uses the Arduino IDE software.

#### 2.3.1 Mechanical Design

The following is the mechanical design scheme of liquid viscosity measuring instrument with a rotating method in 3d form:

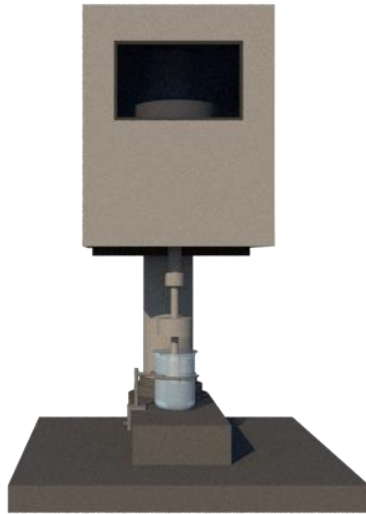

**Figure 3.** Schematic of the 3d design of a fluid viscosity measuring instrument using the rotary method (a)

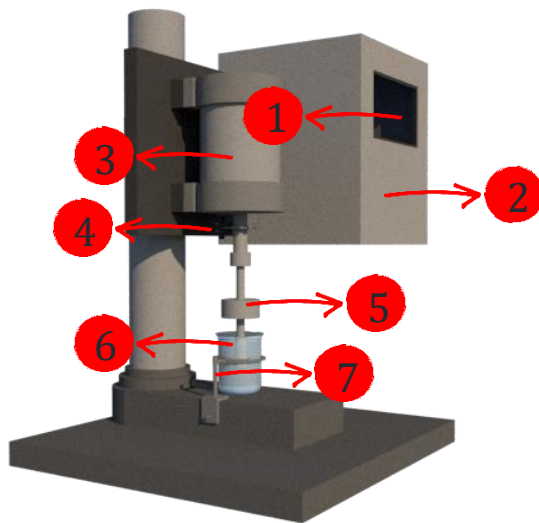

**Figure 4.** Schematic of the 3d design of a fluid viscosity measuring instrument using the rotary method (b)

**Information :**

1. LCD
2. Panel
3. DC motor
4. Optocoupler sensor
5. Stirrer
6. Glass
7. Glass Handle

The following is the result of the realization of the mechanical design scheme of liquid viscosity measuring instrument with the i rotary method:



**Figure 5.** Mechanical Design Results

*2.3.2 Electronic Design*

For electrical design in the form of wiring diagrams of fluid viscosity measuring instruments with IoT-based rotation method. Here is a wiring diagram of the fluid viscosity measuring instrument with IoT-based rotation method.

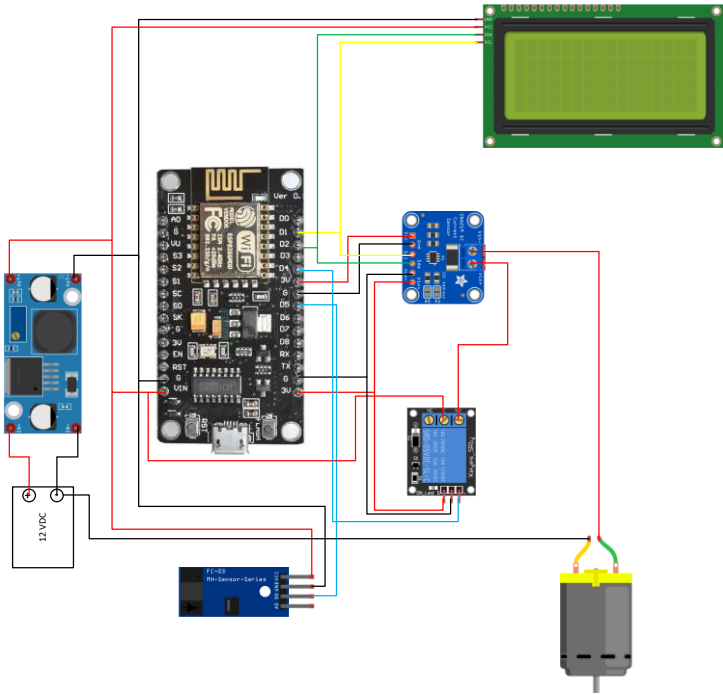

**Figure 6.** Wiring Diagram

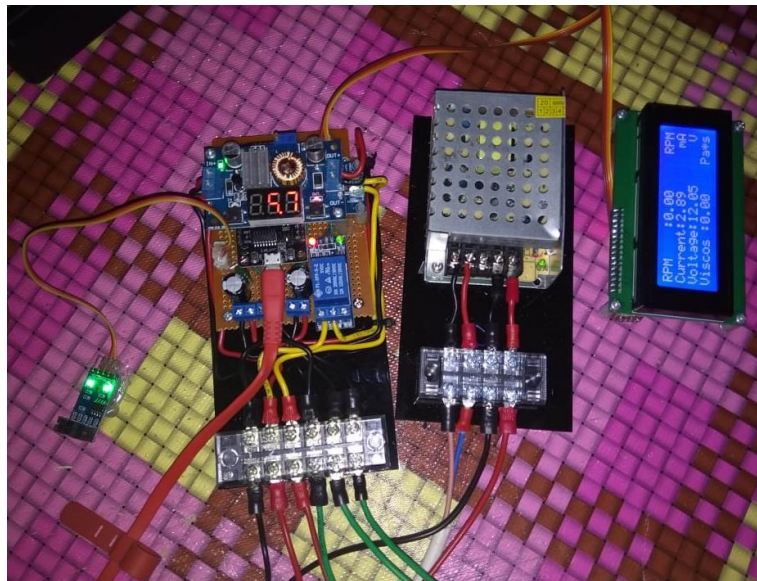

**Figure 7.** Result of wiring diagram realization

### 2.3.3 NodeMCU Software ESP8266

*NodeMcu ESP8266* used as the main microcontroller, which is used as a control between the sensor and the output for viscosity data. This ESP8266 NodeMCU functions as a data sender that connects the sensor to the plant. The data received from the INA219 sensor is in the form of analog data and the data received from the optocoupler sensor is digital data. So that the results of the readings of the two sensors will be processed by the controller which will produce viscosity data using the existing formula. As for the monitoring design for viscosity measurements using a webserver as follows:

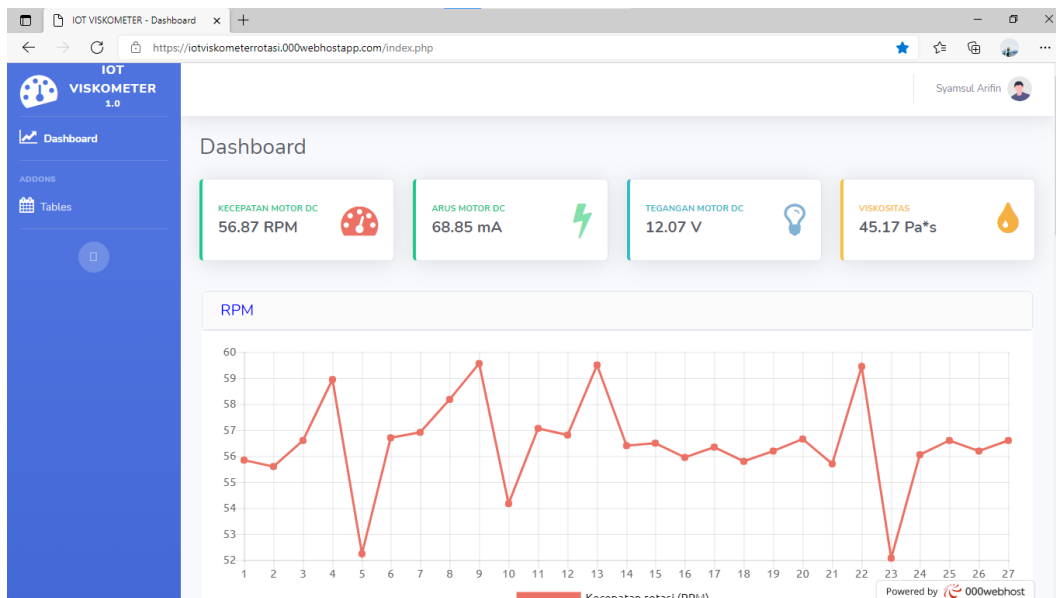

**Figure 8.** Monitoring viscosity measurement using a webserver (a)



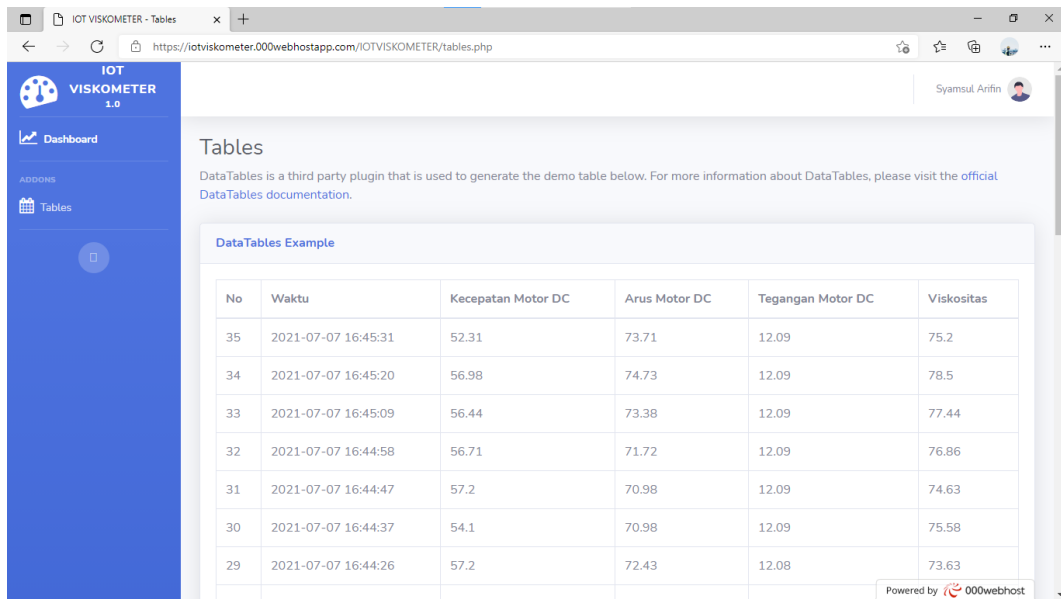

**Figure 9.** Monitoring of viscosity measurement using a webserver (b)

Based on the picture above, the measurement data can be monitored which on the webserver will display the results of measuring the current of the dc motor, the rpm of the dc motor, and the results of the viscosity value. The webserver will also display graphs and tables of measurement results.

### 3. Result And Discussion

#### 3.1 Testing Each Component

Before the components are used to perform a function and are installed on the plant, we must be able to ensure whether the sensors or components that we install on the plant are working properly and the readings are in accordance with the readings of the tools that are considered standard.

##### 3.1.1 Current and Voltage Sensor Testing

In the fluid viscosity measuring plant, one of the variables measured is the current and voltage on the dc motor and monitored through the LCD and webserver. Before the sensor is assembled, the sensor must undergo testing and calibration first.



**Figure 10.** DC motor current test



**Figure 11.** DC motor voltage test

Sensor testing carried out is a fixed value test with a value of 60 mA at DC motor current and 12.02 V at DC motor voltage which refers to a multimeter validator. The steps are as follows:

- a) Setting up measuring instruments and multimeter validators
- b) Attach the measuring instrument to be tested and the validator to the DC motor
- c) Turn on the meter and validator at the same time
- d) Read and record test results
- e) Repeat Steps c and d until you get the amount of data you want
- f) Processing the data obtained from the test results to determine the feasibility level of the sensor

The following is the value of the current and voltage sensor test results with the current value on the DC motor.

**Table 1.** Test results of current and voltage sensors on DC motor current values

No	Tested Tool Readout "INA219 Sensor (mA)"	Validator Reading "Multimeter (mA)"	Correction	(X'-X)	(X'-X) <sup>2</sup>
1	65.01	66.3	1.29	-0.624	0.389376
2	65.01	66.3	1.29	-0.624	0.389376
3	65.01	66.3	1.29	-0.624	0.389376
4	65.43	66.8	1.37	-0.204	0.041616
5	65.98	66.8	0.82	0.346	0.119716
6	65.98	66.8	0.82	0.346	0.119716
7	65.98	66.8	0.82	0.346	0.119716
8	65.98	66.8	0.82	0.346	0.119716
9	65.98	66.8	0.82	0.346	0.119716
10	65.98	66.8	0.82	0.346	0.119716

After testing, the characteristics of the current and voltage sensors will be obtained as follows:

Resolution	0.8	mA
Average	64.634	mA
Standard Deviation	0462846267	
Validator Uncertainty	0.2	mA
Level of confidence	95	%
Coverage Factor	1.8	
Accuracy	1.4	%

Standard Uncertainty	0.146364841		
Mathematical Models	66.65	±	0.616133
U1	0.146364841	mA	65.634
U2	0.180029759	mA	
Ub1	0.1	mA	
Ub2	0.230940108	mA	
Uc	0.342296238	mA	
U95	0.616133228		
veff	0.300871511		
Error Percentage	0.000152438	%	
Decision	The tool is still usable		

**Table 2.** Test results of current and voltage sensors on DC motor voltage values

No	Tested Tool Readout "INA219 (V) Sensor"	Validator Reading "Multimeter (V)"	Correction	(X'-X)	(X'-X)^2
1	12	12.02	0.02	-0.006	3.6E-05
2	12	12.02	0.02	-0.006	3.6E-05
3	12.01	12.02	0.01	0.004	1.6E-05
4	12.02	12.05	0.03	0.014	0.000196
5	12.02	12.05	0.03	0.014	0.000196
6	12.01	12.02	0.01	0.004	1.6E-05
7	12.02	12.05	0.03	0.014	0.000196
8	12	12.02	0.02	-0.006	3.6E-05
9	12	12.02	0.02	-0.006	3.6E-05
10	11.98	12.01	0.03	-0.026	0.000676

After testing, the characteristics of the current and voltage sensors will be obtained as follows:

Resolution	0.8	V	
Average	12.006	V	
Standard Deviation	0.012649111		
Validator Uncertainty	0.2	V	
Level of confidence	95	%	
Coverage Factor	1.8		
Accuracy	0.5	%	
Standard Uncertainty	0.004		
Mathematical Models	12,028	±	0.453213
U1	0.004	V	12.006
U2	0.006804138	V	
Ub1	0.1	V	
Ub2	0.230940108	V	

Uc	0.2517848888	V
U95	0.453212798	V
veff	5.73276E-07	
Error Percentage	1.82907E-05	%
Decision	The tool is still usable	

The following is the result of a comparison chart between the measuring instruments tested and the validator:

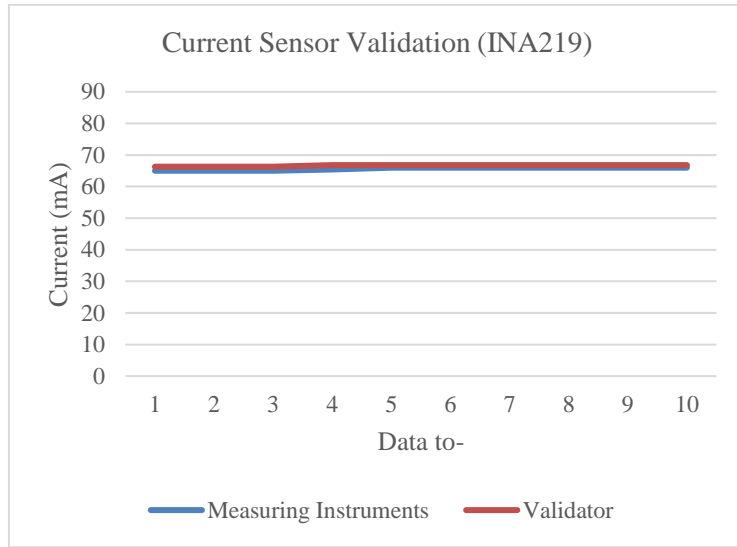

**Figure 12.** Current Sensor Reading Results (INA219)

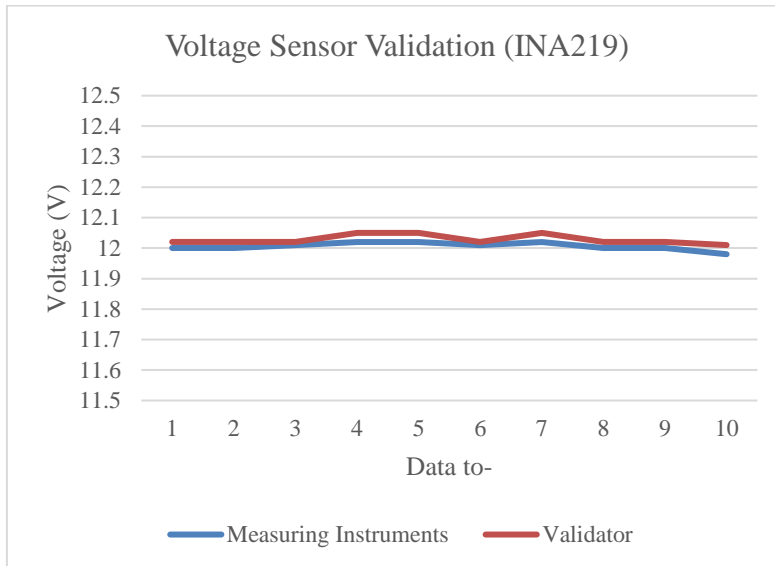

**Figure 13.** Voltage Sensor Reading Results (INA219)

### 3.1.2 Speed Sensor Test

In this plant, a speed sensor is used to measure the speed of a dc motor. So that the results of this speed sensor will be monitored via the LCD and webserver. Before the sensor is assembled and installed in the plant, the sensor must be tested and calibrated first. In this speed sensor test, it is done using a

tachometer as a comparison of the speed sensor in order to determine the level of accuracy and precision of the tool being tested. The results are as follows:



**Figure 14.** Speed sensor test (optocoupler fc 03)



**Figure 15.** Testing dc motor rpm with tachometer

Sensor testing carried out is a fixed value test carried out with a value of 59.2 rpm which refers to the tachometer validator. The steps are as follows:

- a) Setting up measuring instruments and tachometer validator
- b) Attach the measuring instrument to be tested and the validator to the DC motor
- c) Turn on the meter and validator at the same time
- d) Read and record test results
- e) Repeat Steps c and d until you get the amount of data you want
- f) Processing the data obtained from the test results to determine the feasibility level of the sensor

The following is the value of the speed sensor test results on a DC motor:

**Table 3.** Speed sensor test results

No	Tested Tool Readout"FC 03 Optocoupler Sensor (rpm)"	Validator Reading"Tachometer (rpm)"	Correction	(X'-X)	(X'-X)^2
1	56.73	55.5	-1.23	-0.095	0.009025

2	56.73	55.5	-1.23	-0.095	0.009025
3	56.74	55.5	-1.24	-0.085	0.007225
4	56.87	55.6	-1.27	0.045	0.002025
5	56.87	55.6	-1.27	0.045	0.002025
6	56.87	55.6	-1.27	0.045	0.002025
7	56.87	55.6	-1.27	0.045	0.002025
8	56.87	55.6	-1.27	0.045	0.002025
9	56.85	55.6	-1.25	0.025	0.000625
10	56.85	55.6	-1.25	0.025	0.000625

After testing, the characteristics of the speed sensor will be obtained as follows:

Resolution	0.01	rpm	
Average	56.825	rpm	
Standard Deviation	0.063813966		
Validator Uncertainty	0.2	rpm	
Level of confidence	95	%	
Coverage Factor	1.8		
Accuracy	0.05	%	
Standard Uncertainty	0.020179748		
Mathematical Models	55.57	±	0.184404
U1	0.020179748	rpm	56.825
U2	0.008930952	rpm	
Ub1	0.1	rpm	
Ub2	0.002886751	rpm	
Uc	0.102446657	rpm	
U95	0.184403982		
veff	0.01354922	rpm	
Error Percentage	0.000225841	%	
Decision	The tool is still usable		

The following is the result of a comparison chart between the measuring instruments tested and the validator:

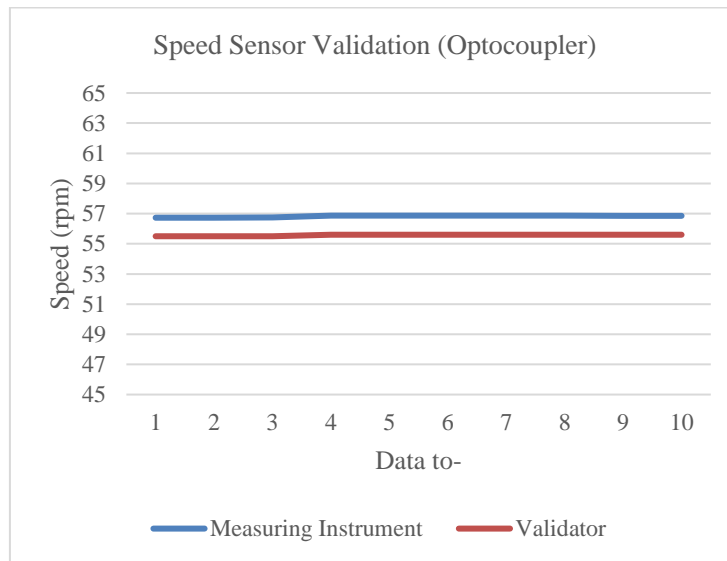

**Figure 16.** Speed Sensor Reading Results

### 3.2 Fluid Viscosity Measuring Instrument Testing



**Figure 17.** Fluid Viscosity Measuring Instrument

After testing each component, it is done testing of fluid viscosity measuring instrument with a rotary method. The testing steps are as follows:

- a) Prepare oil for use as a sample on viscosity measurements
- b) Plug the plug into a power outlet
- c) Press the red push button to start viscosity measurement
- d) Press the green push button to reset the fluid viscosity measurement readings when positioning without load or sample
- e) Perform Step a-d for another sample

The following data of fluid viscosity measuring instrument test results using 3 samples, namely SAE 40 Oil, SAE 20W-50, and SAE 10W-30:

### 3.2.1 Testing with SAE 40 Oil samples

From testing using SAE 40 Oil obtained measurement results such as the following:

**Table 4.** SAE 40 Oil Measurement Result Data

No	Viscosity (Pa.s)		Correction	(X'-X)	(X'-X)^2
	Calculation	Measuring Instrument			
1	41.63	41.55	0.08	-34.674	1202.286
2	40.82	40.75	0.07	-35.474	1258.405
3	41.84	41.45	0.39	-34.774	1209.231
4	41.87	41.37	0.5	-34.854	1214.801
5	41.13	41.07	0.06	-35.154	1235.804
6	41.78	41.12	0.66	-35.104	1232.291
7	41.75	40.56	1.19	-35.664	1271.921
8	40.98	40.62	0.36	-35.604	1267.645
9	40.98	40.61	0.37	-35.614	1268.357
10	40.98	40.61	0.37	-35.614	1268.357
Average	41.376	40.971	0.405		1242.91
	Standard Deviation				11.75164

a. Accuracy

$$\begin{aligned}
 &= accuracy = \frac{100\%}{n} \sum_{t=1}^n \frac{|X_t - P_t|}{X_t} \\
 &= \left[ 1 - \left( \frac{(Average\ Standard\ Reading) - (Average\ Measuring\ Instrument)}{Average\ Standard\ Reading} \right) \right] \\
 &= \left[ 1 - \frac{41.376 - 40.971}{41.376} \right] \\
 &= 1 - (0.0097) \\
 &= 0.99
 \end{aligned}$$

### 3.2.2 Testing with SAE 20W-50 Oil samples

From testing using SAE 20W-50 Oil obtained measurement results such as the following :

**Table 5.** SAE 20W-50 Oil Measurement Result Data

No	Viscosity (Pa.s)		Correction	(X'-X)	(X'-X)^2
	Calculation	Measuring Instrumentas			
1	59.28	59.19	0.09	-53.886	2903.701
2	54.67	54.58	0.09	-58.496	3421.782
3	56.46	56.38	0.08	-56.696	3214.436
4	56.55	56.12	0.43	-56.956	3243.986
5	55.62	55.22	0.4	-57.856	3347.317
6	57.62	56.85	0.77	-56.226	3161.363
7	57.55	56.82	0.73	-56.256	3164.738
8	56.62	56.17	0.45	-56.906	3238.293



9	56.62	56.17	0.45	-56.906	3238.293
10	56.14	55.88	0.26	-57.196	3271.382
Average	56.713	56.338	0.375		3220.529
Standard Deviation					18.91657

a. Accuracy

$$\begin{aligned}
&= accuracy = \frac{100\% \sum_{t=1}^n \frac{|X_t - P_t|}{X_t}}{n} \\
&= \left[ 1 - \frac{((Average\ Standard\ Reading) - (Average\ Measuring\ Instrument))}{Average\ Standard\ Reading} \right] \\
&= \left[ 1 - \frac{56.713 - 56.338}{56.713} \right] \\
&= 1 - (0.0066) \\
&= 0.99
\end{aligned}$$

### 3.2.3 Testing with SAE 10W-30 Oil samples

From testing using SAE 10W-30 Oil, the measurement results are as follows:

**Table 6.** SAE 10W-30 Oil Measurement Result Data

No	Viscosity (Pa.s)		Correction	(X'-X)	(X'-X)^2
	Calculation	Measuring Instruments			
1	68.06	67.96	0.1	-55.763	3109.512
2	66.95	66.85	0.1	-56.873	3234.538
3	67.15	66.75	0.4	-56.973	3245.923
4	66.34	66.03	0.31	-57.693	3328.482
5	65.99	65.12	0.87	-58.603	3434.312
6	66.12	65.95	0.17	-57.773	3337.72
7	67.68	66.85	0.83	-56.873	3234.538
8	67.39	66.42	0.97	-57.303	3283.634
9	67.39	66.42	0.97	-57.303	3283.634
10	67.02	66.22	0.8	-57.503	3306.595
Average	67.009	66.457	0.552		3279.889
Standard Deviation					19.0901

a. Accuracy

$$\begin{aligned}
&= accuracy = \frac{100\% \sum_{t=1}^n \frac{|X_t - P_t|}{X_t}}{n} \\
&= \left[ 1 - \frac{((Average\ Standard\ Reading) - (Average\ Measuring\ Instrument))}{Average\ Standard\ Reading} \right] \\
&= \left[ 1 - \frac{67.009 - 66.457}{67.009} \right] \\
&= 1 - (0.0082) \\
&= 0.99
\end{aligned}$$

### 3.3 Design Model

To facilitate in the analysis of the model that has been made, the model is made as shown in Figure

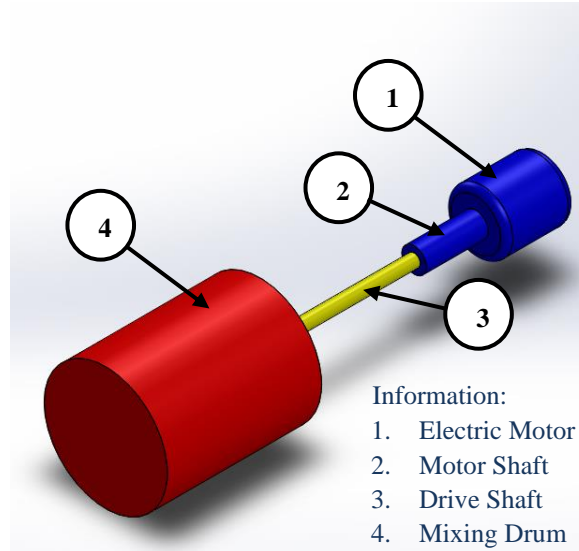
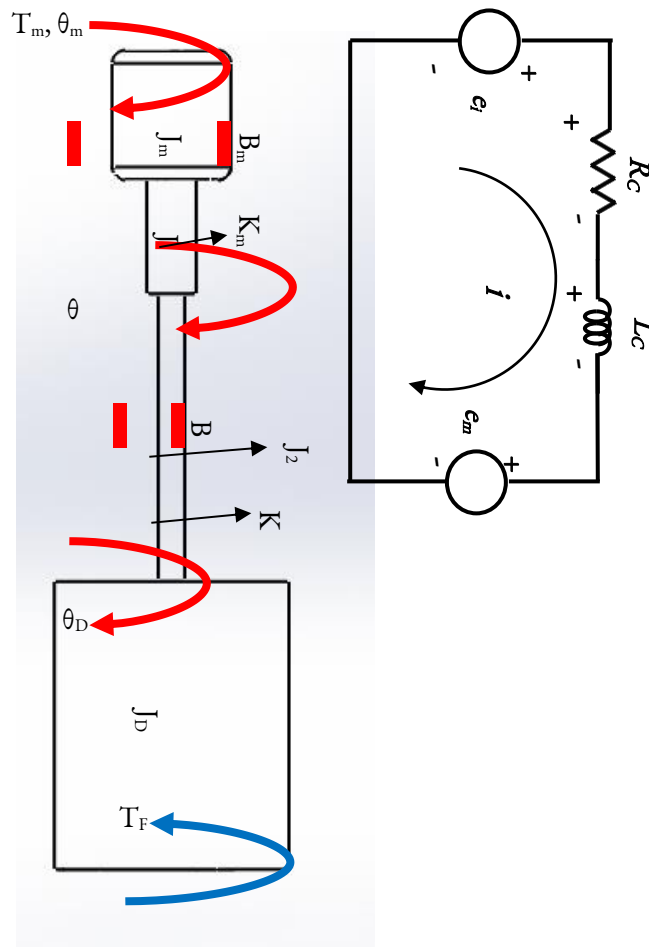

**Figure 18.** Model of mixing drum integrated with motor

Figure 19 is a model image of the design to be analyzed. The system consists of a series of mechanical and electronic components. The components consist of an electric motor integrated with the mixing drum. Between the mixing drum and the electric motor there is a shaft as a component to pass torque from the motor to the Drum.

#### 3.3.1 Model Mathematics

To get a mathematical model of the system that has been designed as in figure 3.8, then the image needs to be simplified to make it easier to get the mathematical model. The simplification of the image can be seen in figure 20.



**Figure 19.** Simplification of fluid viscosity measuring system using rotating drum

Information:  $T_m$  = torque from optimum engine (12 Nm at 320 rpm)

$K_m$  = torque stiffness of the motor shaft

$K$  = torque stiffness of the mixing shaft

$B_m$  = motor damping coefficient

$B$  = damping coefficient of the mixer shaft

$\theta_m$  = motor angle shift

$\theta$  = angle shift between clutch and shaft

$\theta_D$  = drum angle shift

$J_m$  = moment of motor inertia

$J$  = moment of motor shaft inertia

$J_D$  = moment of drum inertia

$T_F$  = shear voltage given fluid to the drum

$e_m$  = induced voltage

$L_C$  = conductor inductance

$R_C$  = conductor resistance

$R_L$  = obstacles in

Figure 20 refers to the simplification components of a fluid viscosity gauge using a rotating drum. The system consists of an electric motor, motor shaft, drive shaft, and rotating drum that directly make contact with the test fluid. The analysis to get the mathematical model is as follows:

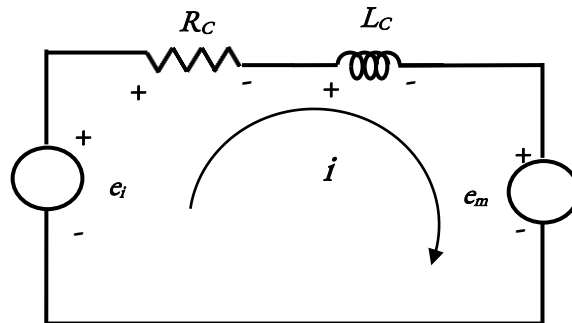

Figure 20. Electrical Analysis

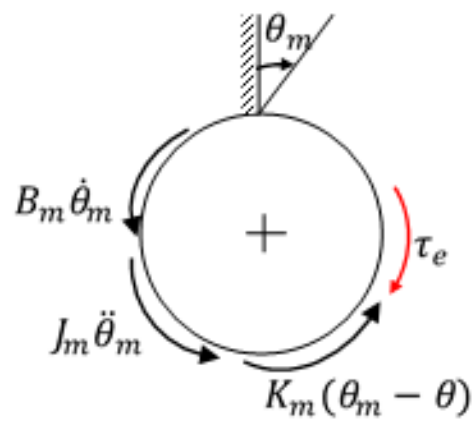

Figure 21. FBD motor body

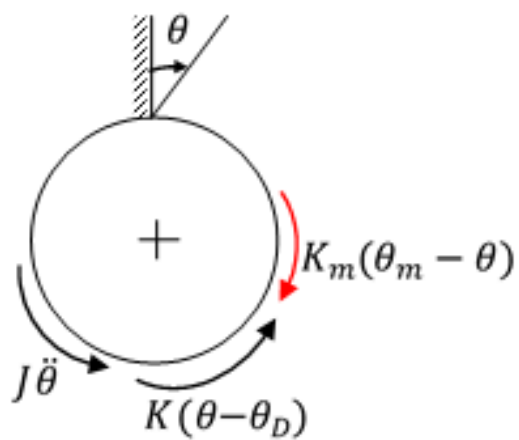
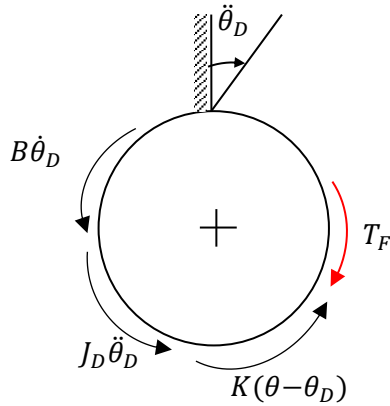

Figure 22. FBD shaft body



**Figure 23.** FBD rotating drum body

From FBD Above obtained Mathematical Equations:

1. Electrical Analysis Results

$$e_i = iR_C + L_C \frac{di}{dt} + e_m \quad \dots \dots \dots (1)$$

2. FBD Motor

$$J_m \ddot{\theta}_m + B_m \dot{\theta}_m + K_m(\theta_m - \theta) = \tau_e$$

$$\ddot{\theta}_m = \frac{1}{J_m} (\tau_e - B_m \dot{\theta}_m - K_m \theta_m + K_m \theta) \quad \dots \dots \dots (2)$$

3. FBD Shaft Body

$$J\ddot{\theta} + K(\theta - \theta_D) = K_m(\theta_m - \theta)$$

$$J\ddot{\theta} + K\theta - K\theta_D = K_m\theta_m - K_m\theta$$

$$\ddot{\theta} = \frac{1}{J} (K_m\theta_m + K\theta_D - K_m\theta - K\theta) \quad \dots \dots \dots (3)$$

4. FBD drum

$$J_D \ddot{\theta}_D + B_D \dot{\theta}_D + K(\theta_D - \theta) = T_F$$

$$J_D \ddot{\theta}_D + B_D \dot{\theta}_D - K\theta + K\theta_D = T_F$$

$$\ddot{\theta}_D = \frac{1}{J_D} (T_F - K\theta_D - B_D \dot{\theta}_D + K\theta) \quad \dots \dots \dots (4)$$

With  $\dot{i} = \frac{di}{dt}$ ,  $\tau_e = 2Nblr_i$  and  $e_m = 2Nblr\dot{\theta}_m$ , then the equation (3.1) is as follows:

$$2Nblr\dot{\theta}_m = i_2 R_C + L_C \frac{di}{dt} + i R_L$$

From the equation (1), (2), (3) and (4), the state variable is obtained as follows:

$$\omega_m = \dot{\theta}_m$$

$$\begin{aligned} \dot{\omega}_m &= \ddot{\theta}_m = \frac{1}{J_m} (2Nblr_i - B_m \dot{\theta}_m - K_m \theta_m + K_m \theta) \\ \omega &= \dot{\omega} \\ \dot{\omega} &= \ddot{\theta} = \frac{1}{J} (K_m \theta_m + K \theta_D - K_m \theta - K \theta) \\ \omega_D &= \dot{\theta}_D \\ \dot{\omega}_D &= \ddot{\theta}_D = \frac{1}{J_D} (T_F + K \theta_D - B_D \dot{\theta}_D - K \theta) \\ \dot{i} &= \frac{1}{L_c} (e_i - 2Nblr \dot{\theta}_m - iR_c) \end{aligned} \quad \dots \dots \dots (5)$$

### 3.3.2 Calculation of Shaft Torque Rigidity and Bearing Friction Coefficient

The amount of torque stiffness of the shaft can be done with the following equations:

$$K = \frac{\pi \cdot G \cdot d^4}{32 l} \quad \dots \dots \dots (6)$$

where:

$K$  = stiffness shaft (N/m)

$G$  = sliding modulus (N/m<sup>2</sup>), the material used aluminum steel alloy, so large

$G = 2.6 \times 10^6$  N/m<sup>2</sup>

$l$  = length of motor shaft,  $l=0.02$  m

$d$  = diameter of motor shaft (m),  $d = 0.02$  m

$l$  = shaft length,  $l=0.05$  m

$d$  = shaft diameter (m),  $d = 0.01$  m

So obtained the rigidity of the torque of the motor is:

$$K_m = \frac{3,14 \times 2,6 \times 10^6 \times 0,02^4}{32 \times 0,02} = 2,041 \times 10^{-4} \text{ kgm}^2 \text{ s}^{-2}$$

While the rigidity of the shaft torque is:

$$K = \frac{3,14 \times 2,6 \times 10^6 \times 0,01^4}{32 \times 0,05} = 5,1025 \times 10^{-4} \text{ kgm}^2 \text{ s}^{-2}$$

While the coefficient of friction of the bearing is as follows:

$$B = \frac{2\pi\mu R^3 l}{d}$$

where:

$B$  = attenuation coefficient (Ns/m)

$\mu = 0,3445$

$R$  = axis radius

$l$  = length of the arm affected by friction

$d$  = fluid height (0.1 mm)

From the data above, the attenuation coefficient value is obtained

$$B_m = B = \frac{2 \cdot (3,14) \cdot (0,3445) \cdot (0,01)^3 \cdot (0,01)}{0,0001} = 0,00022 \text{ Ns/m}$$

### 3.3.3 Simulation Results

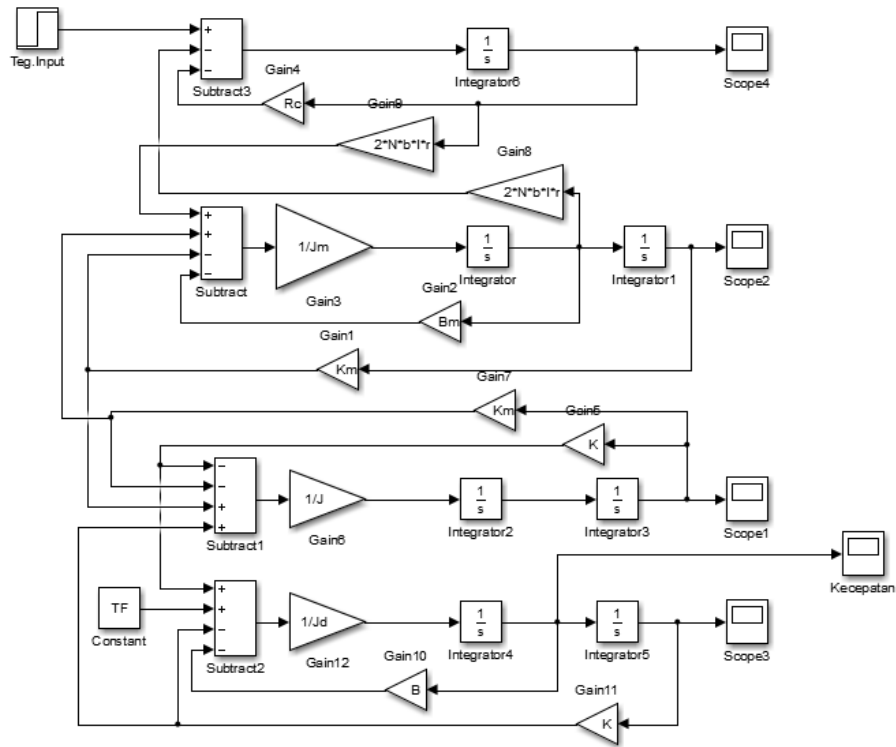

**Figure 24.** Simulink block viscosity measuring system with electrical voltage input

Figure 25 is a Simulink block for fluid viscosity measuring system using rotating drum. These chart blocks are designed based on equations (1), (2), (3), (4), (5) and (6). The input of this system is an electric voltage of 5 Volts because the motor used is a DC electric motor with an input of 12 V. The simulation result of this system can be seen in figure 5.4. From the results of this simulation obtained that initially the drum motor spins at a low speed until the 10th second of the motor rotation about 6 rad / s and as time increases, then the motor rotation will increase until the 60th second of the motor rotation begins to be constant this is due to the large shear voltage generated by the fluid at the beginning of the motor is turned on very large and decreases over time.

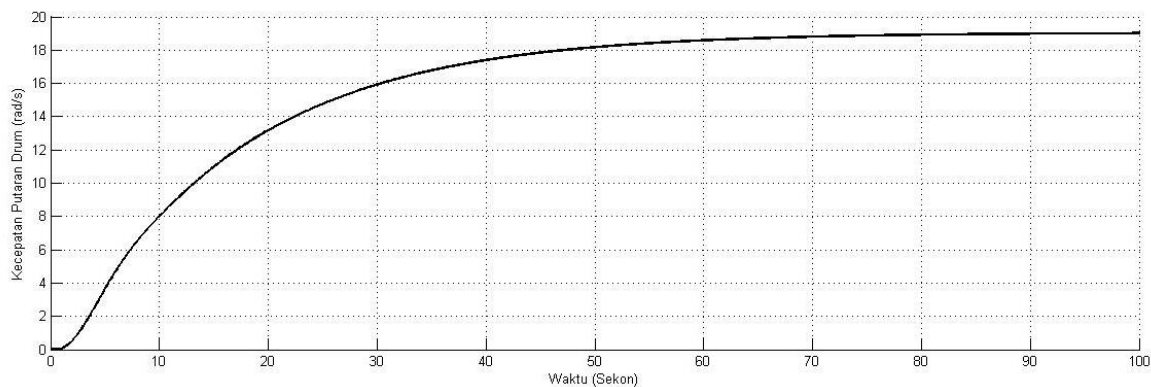

**Figure 25.** Simulation result of fluid viscosity measuring instrument

#### 4. Conclusion

The design of the fluid viscosity measuring instrument using the Internet of Things (IoT)-based rotary method was successfully created, starting from mechanical design, electrical design, and also a monitoring system using a webserver. SAE 40 Oil measurement results in the accuracy of 0.99, SAE 20W-50 Oil measurement obtained an accuracy value of 0.99, and in SAE 10W-30 Oil measurement obtained an accuracy value of 0.99.

#### References

- [1] R. R. Firmansyah, "RANCANG BANGUN VISKOMETER ROTASI SEBAGAI PENGUKUR KEKENTALAN FLUIDA CAIR," *Jurnal Inovasi Fisika Indonesia*, pp. Volume 08 Nomer 2 hal 28-32, 2019.
- [2] Haribima, "Ketahui Lebih Banyak Manfaat Rumus Viskositas," 19 Maret 2019. [Online]. Available: <https://ibs.co.id/id/rumus-viskositas/>.
- [3] R. Samdara, "Rancang Bangun Viskometer Dengan Metode Rotasi Berbasis Komputer," *Jurnal Gradien*, pp. Volume 4 Nomer 2 hal 342-348, 2008.
- [4] e. a. Faqihza Mukhlis, "Pembuatan Prototipe Viskometer Bola Jatuh Menggunakan Sensor Magnet dan Bola Magnet," *J.Oto.Ktrl.Inst*, pp. Volume 5 Nomer 2 hal 101-111, 2013.
- [5] R. Mulyana, "PENGUKURAN VISKOSITAS AIR MEMAKAI PIPA KAPILER DENGAN METODE POISEUILLE," 2009.
- [6] Kirkup, "Experimental Method An Introduction to The Analysis and Presentation of Data," *John Willey & Sons*, 1994.
- [7] J. R. Cho, "Braking Distance Prediction by Hydroplaning Analysis of 3-D Patterned Tire Model," *Journal of System Design and Dynamics*, vol. 1, no. 3, pp. 398-409, 2007.